



DS 201

Electronic Pressure Switch

Ceramic Sensor

accuracy according to IEC 61298-2:
0.5 % FSO

Nominal pressure

from 0 ... 400 mbar up to 0 ... 600 bar

Contacts

1, 2 or 4 independent PNP contacts,
freely configurable

Analogue output

2-wire: 4 ... 20 mA

3-wire: 4 ... 20 mA / 0 ... 10 V

others on request

Special characteristics

- ▶ indication of measured values on a 4-digit LED display
- ▶ rotatable and configurable display module

Optional versions

- ▶ **IS-version**
Ex ia = intrinsically safe for gases
- ▶ pressure port PVDF
- ▶ customer specific versions



The electronic pressure switch DS 201 is the successful combination of

- ▶ intelligent pressure switch
- ▶ digital display

and has been specially designed for universal usage in industry applications. The DS 201 is available with flush pressure ports for viscous, pasty, and highly polluted media.

As standard the DS 201 offers a PNP contact and a rotatable display module with 4-digit LED display. Optional versions like e.g. an intrinsically safe version, max. four contacts and an analogue output complete the profile.

Preferred areas of use are

-  Plant and machine engineering
-  Environmental engineering
(water – sewage – recycling)



Input pressure range ¹																		
Nominal pressure gauge [bar]	-1...0	0.4	0.6	1	1.6	2.5	4	6	10	16	25	40	60	100	160	250	400	600
Nominal pressure absolute [bar]	-	-	0.6	1	1.6	2.5	4	6	10	16	25	40	60	100	160	250	400	600
Level gauge [mH ₂ O]	-	4	6	10	16	25	40	60	100	160	250	400	600	-	-	-	-	-
Overpressure [bar]	4	1	2	2	4	4	10	10	20	40	40	100	100	200	400	400	600	800
Burst pressure ≥ [bar]	7	2	4	4	5	5	12	12	25	50	50	120	120	250	500	500	650	880
Vacuum resistance	p _N ≥ 1 bar: unlimited vacuum resistance p _N < 1 bar: on request																	

¹ PVDF pressure port possible for nominal pressure ranges up to 60 bar

Contact ²	
Standard	1 PNP contact
Options	2 independent PNP contacts 4 independent PNP contacts (possible with M12x1, 8-pin for 4 ... 20 mA/3-wire; 0 ... 10 V/3-wire on request)
Max. switching current	4 ... 20 mA / 2- and 3-wire: contact rating 125 mA, short-circuit resistant; V _{Switch} = V _S - 2V 0 ... 10 V / 3-wire: contact rating 125 mA, short-circuit resistant
Accuracy of contacts ³	≤ ± 0.5 % FSO
Repeatability	≤ ± 0.2 % FSO
Switching frequency	max. 10 Hz
Switching cycles	> 100 x 10 ⁶
Delay time	0 ... 100 sec

² max. 1 contact for 2-wire current signal with plug ISO 4400 as well as 2-wire current signal with IS-protection
no contact possible with 3-wire in combination with plug ISO 4400

Analogue output (optionally) / Supply	
2-wire current signal	4 ... 20 mA / V _S = 13 ... 36 V _{DC} permissible load: R _{max} = [(V _S - V _{Smin}) / 0.02 A] Ω response time: < 10 msec
2-wire current signal with IS-protection	4 ... 20 mA / V _S = 15 ... 28 V _{DC} permissible load: R _{max} = [(V _S - V _{Smin}) / 0.02 A] Ω response time: < 10 msec
3-wire current signal	4 ... 20 mA / V _S = 19 ... 30 V _{DC} adjustable (turn-down of span 1:5) ⁴ permissible load: R _{max} = 500 Ω response time: < 0.5 sec
3-wire voltage signal	0 ... 10 V / V _S = 15 ... 36 V _{DC} permissible load: R _{min} = 10 kΩ response time: < 3 msec
Without analogue output	V _S = 15 ... 36 V _{DC}
Accuracy ³	≤ ± 0.5 % FSO

³ accuracy according to IEC 61298-2 – limit point adjustment (non-linearity, hysteresis, repeatability)

⁴ with turn-down of span the analogue signal is adjusted automatically to the new measuring range

Thermal effects (offset and span)	
Thermal error	≤ ± 0.2 % FSO / 10 K
In compensated range	0 ... 85 °C

Permissible temperatures	
Medium ⁵	-40 ... 125 °C
Electronics / environment	-40 ... 85 °C
Storage	-40 ... 100 °C

⁵ for pressure port in PVDF the medium temperature is -30 ... 60 °C

Electrical protection	
Short-circuit protection	permanent
Reverse polarity protection	no damage, but also no function
Electromagnetic compatibility	emission and immunity according to EN 61326

Mechanical stability	
Vibration	20 g RMS / 10 ... 2000 Hz according to DIN EN 60068-2-6
Shock	500 g / 1 msec half sine according to DIN EN 60068-2-27

Materials			
Pressure port / housing	standard: option for G1/2" open port (up to 60 bar): option for G3/4" flush (0.6 bar ≤ p _N ≤ 25 bar):	pressure port	housing
		stainless steel 1.4404 PVDF PVDF	stainless steel 1.4404 stainless steel 1.4404 PVDF
Display housing	PA 6.6, polycarbonate		
Seals (media wetted)	standard: FKM option: EPDM (p _N ≤ 160 bar) others on request		
Diaphragm	ceramics Al ₂ O ₃ 96 %		
Media wetted parts	pressure port, seals, diaphragm		

Explosion protection (only for 4 ... 20 mA / 2-wire)					
Approval AX14-DS 201	IBExU 06 ATEX 1050 X zone 1: II 2G Ex ia IIC T4 Gb				
Safety tech. maximum values	$U_i = 28 \text{ V}$, $I_i = 93 \text{ mA}$, $P_i = 660 \text{ mW}$, $C \approx 0 \text{ nF}$, $L_i \approx 0 \text{ }\mu\text{H}$				
Max. switching current ⁶	70 mA				
Permissible temperatures for environment	-25 ... 70 °C				
Connecting cables (by factory)	cable capacitance: signal line/shield also signal line/signal line: 100 pF/m cable inductance: signal line/shield also signal line/signal line: 1 $\mu\text{H}/\text{m}$				
⁶ the real switching current in the application depends on the power supply unit					
Miscellaneous					
Display	4-digit, red 7-segment-LED display digit height 7 mm range of indication -1999 ... +9999 accuracy 0.1 % \pm 1 digit digital damping 0.3 ... 30 sec (programmable); measured value update 0.0 ... 10 sec (programmable)				
Option oxygen application ⁷	for $p_N \leq 25 \text{ bar}$: O-ring in FKM Vi 567 (with BAM-approval); permissible maximum values are 25 bar / 150° C				
Current consumption (without contacts)	2-wire signal output current: max. 25 mA 3-wire signal output current: approx. 45 mA + signal current 3-wire signal output voltage: approx. 45 mA				
Ingress protection	IP 65				
Installation position	any				
Weight	approx. 200 g				
Operational life	100 million load cycles				
CE-conformity	EMC Directive: 2014/30/EU Pressure Equipment Directive: 2014/68/EU (module A) ⁸				
ATEX Directive	2014/34/EU				
⁷ not possible with flush pressure ports					
⁸ this directive is only valid for devices with maximum permissible overpressure > 200 bar					
Wiring diagrams					
<p>2-wire-system (current)</p>			<p>3-wire-system (current/voltage)</p>		
Pin configuration					
Electrical connection	M12x1 plastic (5-pin)	M12x1 metal (5-pin)	M12x1 plastic (8-pin)	ISO 4400	Binder series 723 (5-pin)
Supply +	1	1	1	1	1
Supply -	3	3	3	2	3
Signal + (only 3-wire)	2	2	2	3	2
Contact 1	4	4	4	3	4
Contact 2	5	5	5	-	5
Contact 3	-	-	6	-	-
Contact 4	-	-	7	-	-
Shield	via pressure port	plug housing/pressure port	via pressure port	ground contact	plug housing/pressure port

Electrical connections (dimensions mm / in)

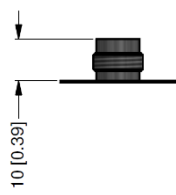

M12x1 plastic
(5-pin)

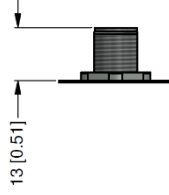

M12x1 metal
(5-pin)

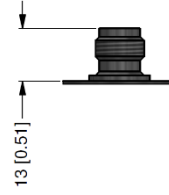

M12x1 plastic
(8-pin)

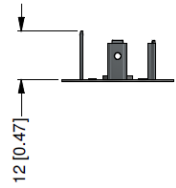

ISO 4400

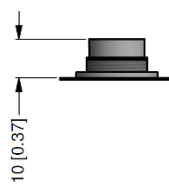

Binder series 723
(5-pin)

Dimensions (mm / in)

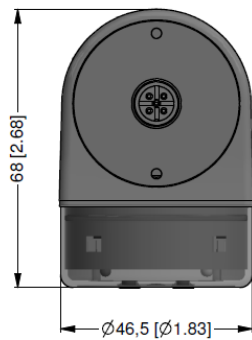
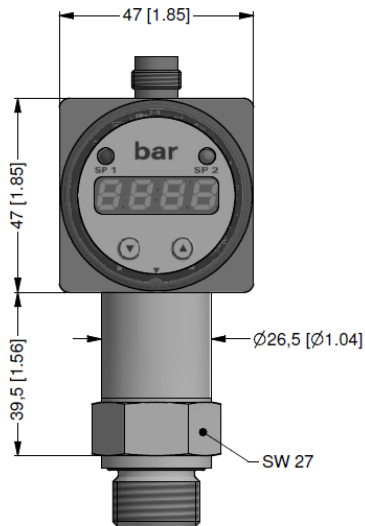

rotatability of display module



Mechanical connection (dimensions mm / in)

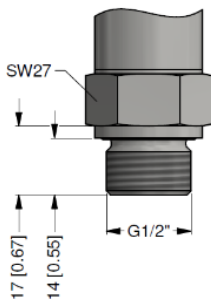

G1/2" DIN 3852

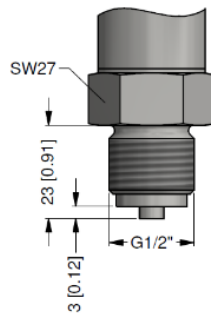

G1/2" EN 837

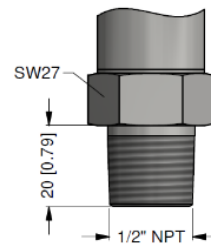

1/2" NPT

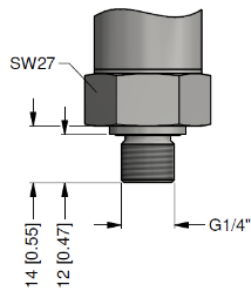

G1/4" DIN 3852

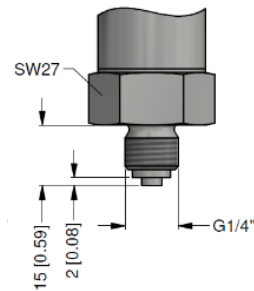

G1/4" EN 837

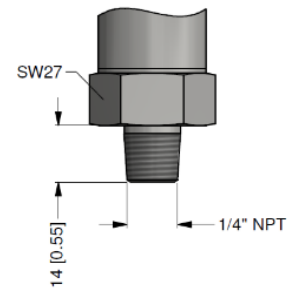

1/4" NPT

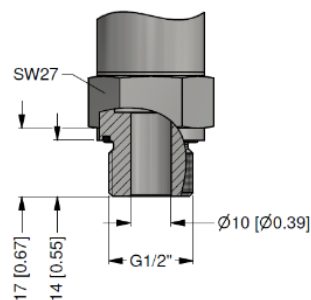

G1/2" open port
DIN 3852

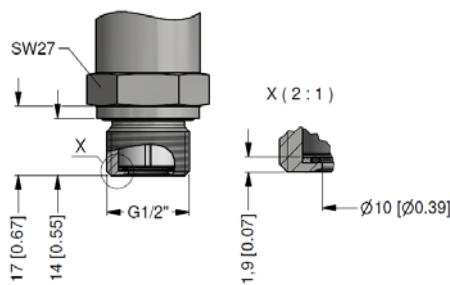

G1/2" semi-flush DIN 3852
(0.6 bar ≤ p_N ≤ 60 bar gauge)

length of device: 97.5 mm (without plug)

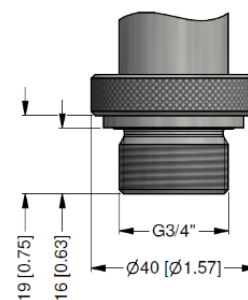

G3/4" semi-flush DIN 3852
(0.6 bar ≤ p_N ≤ 60 bar gauge)

length of device: 87.5 mm (without plug)

⇨ metric threads and other versions on request

© 2025 BDSENSORS GmbH – The specifications given in this document represent the state of engineering at the time of publishing. We reserve the right to make modifications to the specifications and materials.

Ordering code DS 201

DS 201

□□□ - □□□□ - □ - □ - □ - □□□ - □□□□ - □ - □ - □ - □□□

Pressure										
	gauge in bar	7	8	2						
	gauge in mH ₂ O	7	8	E						
	absolute in bar	7	8	3						
Input										
	[mH ₂ O]	[bar]								
	4	0.4	4	0	0	0				
	6	0.6	6	0	0	0				
	10	1.0	1	0	0	1				
	16	1.6	1	6	0	1				
	25	2.5	2	5	0	1				
	40	4.0	4	0	0	1				
	60	6.0	6	0	0	1				
	100	10	1	0	0	2				
	160	16	1	6	0	2				
	250	25	2	5	0	2				
	400	40	4	0	0	2				
	600	60	6	0	0	2				
	100	100	1	0	0	3				
	160	160	1	6	0	3				
	250	250	2	5	0	3				
	400	400	4	0	0	3				
	600	600	6	0	0	3				
	-1 ... 0		X	1	0	2				
	customer		9	9	9	9				consult
Analogue output										
	without					0				
	4 ... 20 mA / 2-wire					1				
	0 ... 10 V / 3-wire					3				
	4 ... 20 mA / 3-wire, adjustable					7				
	intrinsic safety 4 ... 20 mA / 2-wire ¹					E				
	customer					9				consult
Contact										
	1 contact ^{1,2}					1				
	2 contacts ^{1,2}					2				
	4 contacts ³					4				consult
Accuracy										
	0.5 % FSO					5				
	customer					9				consult
Electrical connection										
	male plug M12x1 (5-pin) / plastic version					N	0	1		
	male plug M12x1 (8-pin) / plastic version ³					M	5	0		
	male plug M12x1 (5-pin) / metal version					N	1	1		
	male and female plug ISO 4400 ²					1	0	0		
	male plug Binder series 723 (5-pin)					2	0	4		
	customer					9	9	9		consult
Mechanical connection										
	G1/2" DIN 3852					1	0	0		
	G1/2" EN 837					2	0	0		
	G1/4" DIN 3852					3	0	0		
	G1/4" EN 837					4	0	0		
	G1/2" DIN 3852 with ⁴ semi-flush sensor					F	0	0		
	G3/4" DIN 3852 with ⁵ semi-flush sensor					K	0	0		
	G1/2" DIN 3852 open pressure port					H	0	0		
	1/2" NPT					N	0	0		
	1/4" NPT					N	4	0		
	customer					9	9	9		consult
Seal										
	FKM					1				
	EPDM ⁶					3				
	customer					9				consult
Pressure port										
	stainless steel 1.4404 (316L)					1				
	PVDF ⁷					B				
	customer					9				consult
Diaphragm										
	ceramics Al ₂ O ₃ 96%					2				
	customer					9				consult
Special version										
	standard					0	0	0		
	oxygen application ⁸					0	0	7		
	customer					9	9	9		consult

© 2024 BD|SENSORS GmbH - The specifications given in this document represent the state of engineering at the time of publishing. We reserve the right to make modifications to the specifications and materials.

¹ with IS version max. 1 contact possible

² with connector ISO 4400 and output 2-wire version only max. 1 contact possible; with 3-wire version no contact possible

³ 4 contacts and M12x1, 8-pin only possible in combination and together with 4 ... 20 mA/3-wire; 0 ... 10 V/3-wire on request

⁴ possible for nominal pressure ranges $p_N \geq 0.6$ bar up to $p_N \leq 60$ bar gauge, absolute on request

⁵ possible for nominal pressure ranges $p_N \geq 0.6$ bar up to $p_N \leq 60$ bar gauge

⁶ possible for nominal pressure ranges $p_N \leq 160$ bar

⁷ PVDF only with G1/2" DIN 3852 open pressure port (up to 60 bar) and G3/4" DIN 3852 with flush sensor (0.6 bar $\leq p_N \leq 25$ bar); permissible medium temperature: -30 ... 60 °C

⁸ oxygen application with FKM-seal up to 25 bar possible, flush version on request